

BRIZO®

BATHROOM FAUCET

- Allaria® Collection
- Single Handle Two Hole Wall Mount





STANDARD SPECIFICATIONS:

- Max flow rate 1.2 gpm @ 60 psi, 4.5 L/Min @ 414 kPa
- Control mechanism - 25 mm ceramic mixing cartridge with metal stem and 180° rotation
- Spout features laminar water efficient flow
- Solid brass fabricated body
- Drain sold separately
- Rough-in R85800 required for installation, not included
- Optional 7 3/4" (197 mm) back plate - 696767-▲ (not included)
- LHP - Less Handle Program. See handle options below

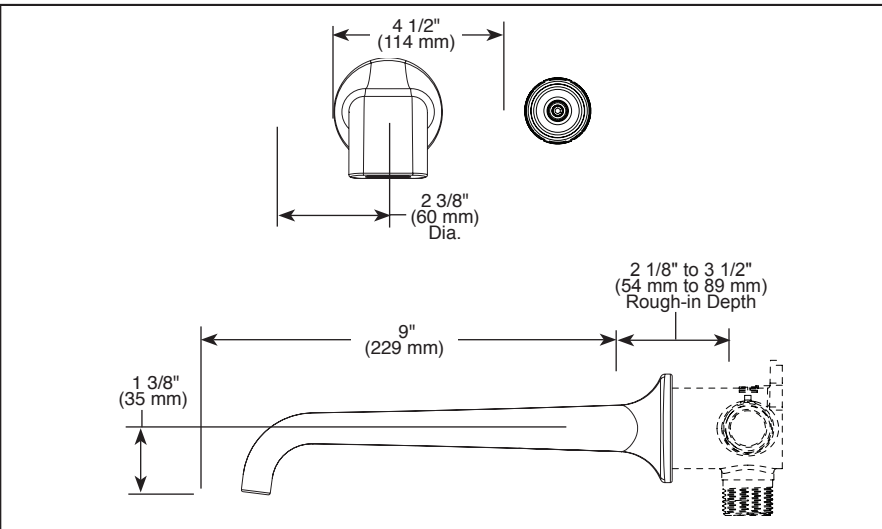
WARRANTY

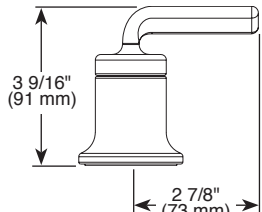
- Parts and Finish - Lifetime limited warranty; or for commercial purchasers, 10 years for multi-family residential (apartments and condominiums) and 5 years for all other commercial uses, in each case from the date the product is received by the original purchaser or their authorized representative (installation contractor, etc.).
- Please go to www.brizo.com for the complete details of our limited warranty.

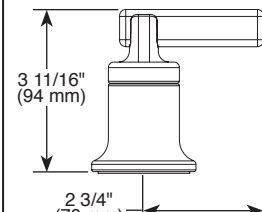

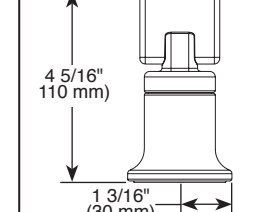
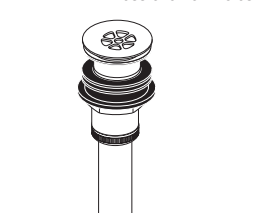
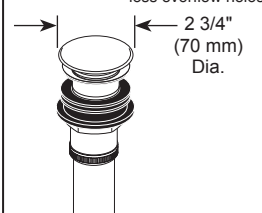
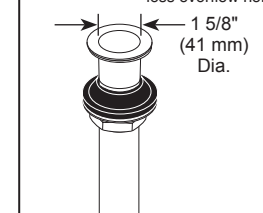
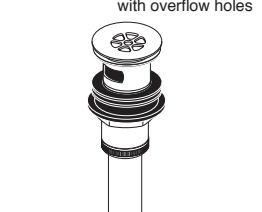
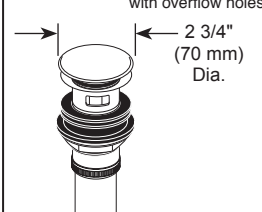
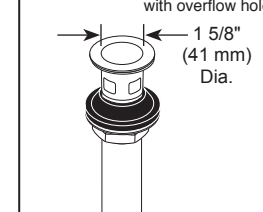
<p>HL5867-▲ </p>  <p>3 9/16" (91 mm) 2 7/8" (73 mm)</p>	<p>HL5868-▲ </p>  <p>3 11/16" (94 mm) 2 3/4" (70 mm)</p>	<p>HK5867-▲ </p>  <p>4 5/16" (110 mm) 1 3/16" (30 mm)</p>
<p>RP72411 ▲ Grid Strainer Drain less overflow holes</p> 	<p>RP72413 ▲ Push Button Drain less overflow holes</p>  <p>2 3/4" (70 mm) Dia.</p>	<p>RP81627 ▲ Push Button Drain less overflow holes</p>  <p>1 5/8" (41 mm) Dia.</p>
<p>RP72412 ▲ Grid Strainer Drain with overflow holes</p> 	<p>RP72414 ▲ Push Button Drain with overflow holes</p>  <p>2 3/4" (70 mm) Dia.</p>	<p>RP81628 ▲ Push Button Drain with overflow holes</p>  <p>1 5/8" (41 mm) Dia.</p>



COMPLIES WITH:

- ASME A112.18.1 / CSA B125.1
- ASME A112.18.2 / CSA B125.2
- EPA WaterSense®
-  ICC/ANSI A117.1

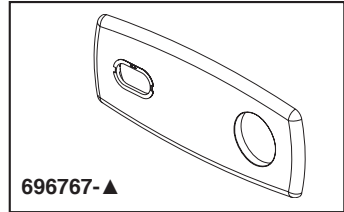

▲ Designate Finish Suffix

Brizo reserves the right (1) to make changes in specifications and materials, and (2) to change or discontinue models, both without notice or obligation. Dimensions are for reference only. See current full-line price book or www.brizo.com for finish options and product availability.

Brizo Kitchen & Bath Faucet Company

55 E. 111th Street, Carmel, IN 46280
 350 South Edgeware Road, St. Thomas, ON N5P 4L1
 © 2026 Brizo Kitchen & Bath Faucet Company

BRIZO^{MD}

ROBINET POUR SALLE DE BAIN

- Collection Allaria^{MD}
- Installation au mur à deux trous avec poignée unique

SPÉCIFICATIONS STANDARDS :

- Débit maximal 1,2 gpm à 60 psi, 4,5 L/min à 414 kPa
- Mécanisme de contrôle - cartouche mélangeuse en céramique de 25 mm avec tige métallique et rotation de 180°
- Bec est doté d'un flux laminaire économe en eau
- Corps fabriqué de laiton massif
- Drain vendu séparément
- Plomberie brute R85800 requise pour l'installation, non incluse
- Plaque de finition de 7 3/4 po (197 mm) en option - 696767-▲ (non incluse)
- LHP - Programme sans poignée. Voir les options de poignées ci-dessous.

GARANTIE

- Pièces et finition – Garantie à vie limitée; ou pour les clients commerciaux, 10 ans pour les résidences multifamiliales (appartements et condominiums) et 5 ans pour tout autre usage commercial, dans tous les cas à compter de la date de réception du produit par l'acheteur initial ou son représentant autorisé (installateur, etc.).
- Veuillez consulter fr.brizofaucet.ca pour tous les détails de notre garantie limitée.



CONFORME À :

- ASME A112.18.1 / CSA B125.1
- ASME A112.18.2 / CSA B125.2
- EPA WaterSense^{MD}
- ♿ ICC/ANSI A117.1

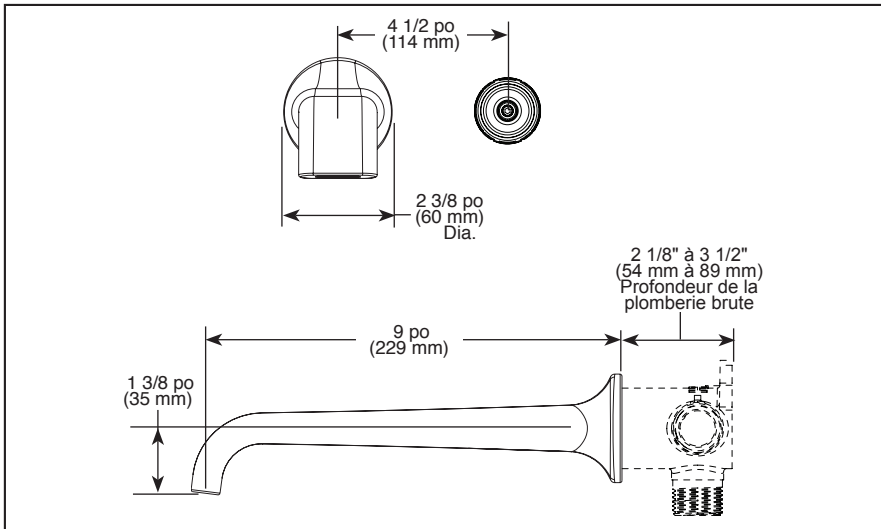
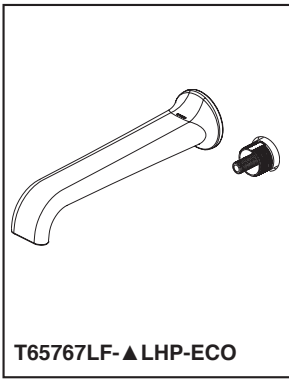
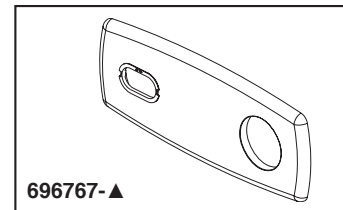

<p>HL5867-▲ ♿</p> <p>3 9/16 po (91 mm) 2 7/8 po (73 mm)</p>	<p>HL5868-▲ ♿</p> <p>3 11/16 po (94 mm) 2 3/4 po (70 mm)</p>	<p>HK5867-▲ ♿</p> <p>4 5/16 po (110 mm) 1 3/16 po (30 mm)</p>
<p>RP72411▲</p> <p>Drain à crépine grillagée sans trous de trop-plein</p>	<p>RP72413▲</p> <p>2 3/4 po (70 mm) Dia.</p> <p>Drain à bouton-poussoir sans trous de trop-plein</p>	<p>RP81627▲</p> <p>1 5/8 po (41 mm) Dia.</p> <p>Drain à bouton-poussoir sans trous de trop-plein</p>
<p>RP72412▲</p> <p>Drain à crépine grillagée avec trous de trop-plein</p>	<p>RP72414▲</p> <p>2 3/4 po (70 mm) Dia.</p> <p>Drain à bouton-poussoir avec trous de trop-plein</p>	<p>RP81628▲</p> <p>1 5/8 po (41 mm) Dia.</p> <p>Drain à bouton-poussoir avec trous de trop-plein</p>

▲ Désigne le suffixe approprié de la finition

Brizo se réserve le droit (1) d'effectuer des changements dans les spécifications et les matériaux, et (2) de modifier ou d'abandonner certains modèles, dans les deux cas sans préavis ni obligation. Les dimensions sont à titre indicatif seulement. Consultez le Livre des prix courants de la gamme complète ou fr.brizofaucet.ca pour la disponibilité des produits et des options.

BSP-L-T65767LF-LHP Rév. C

Brizo Kitchen & Bath Faucet Company

55 E. 111th Street, Carmel, IN 46280
350 South Edgware Road, St. Thomas, ON N5P 4L1
© 2026 Brizo Kitchen & Bath Faucet Company